

Bailey Marine

LOCKER LATCH ASSEMBLY

BMLL112A

S316 STAINLESS STEEL CONSTRUCTION

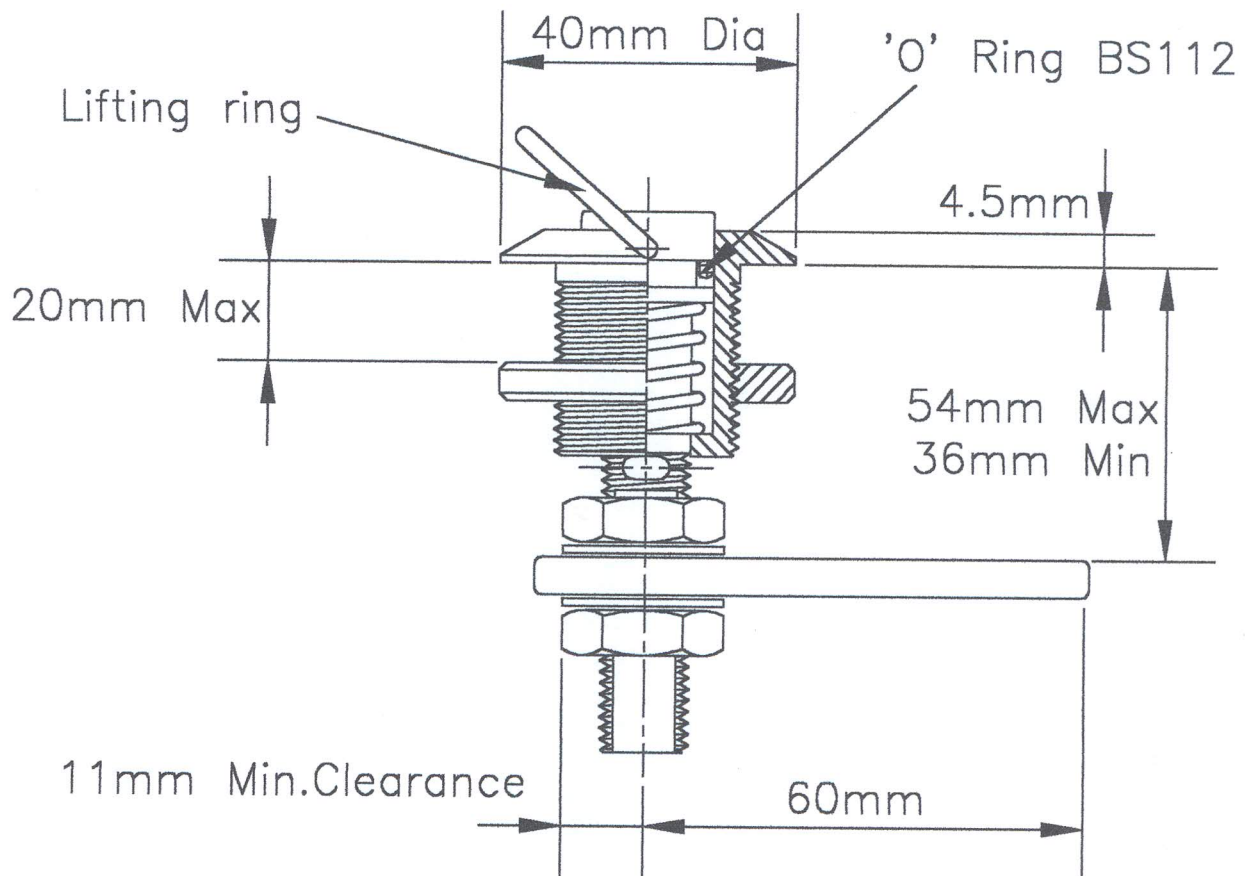

Adjust nuts so that head of screw is slightly underflush when latch is closed

12Kg Holding Force

