

LOCKER LATCH ASSEMBLY
BMLL115SM (surface mounted)

ALL S316 STAINLESS STEEL CONSTRUCTION

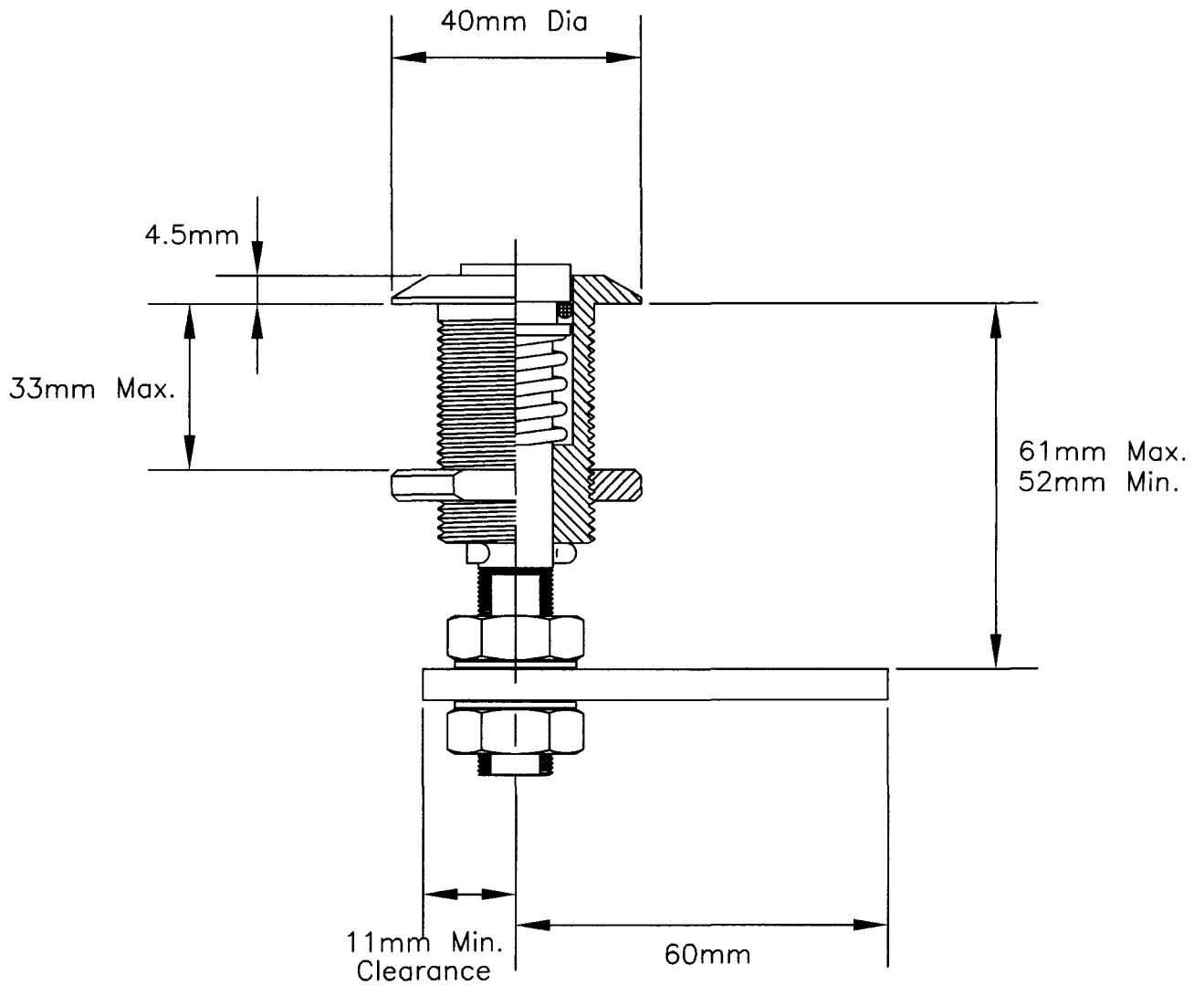

12Kg Holding Force

