

LOCKER LATCH ASSEMBLY
BMLL117FM (flush mounted)

ALL S316 STAINLESS STEEL CONSTRUCTION

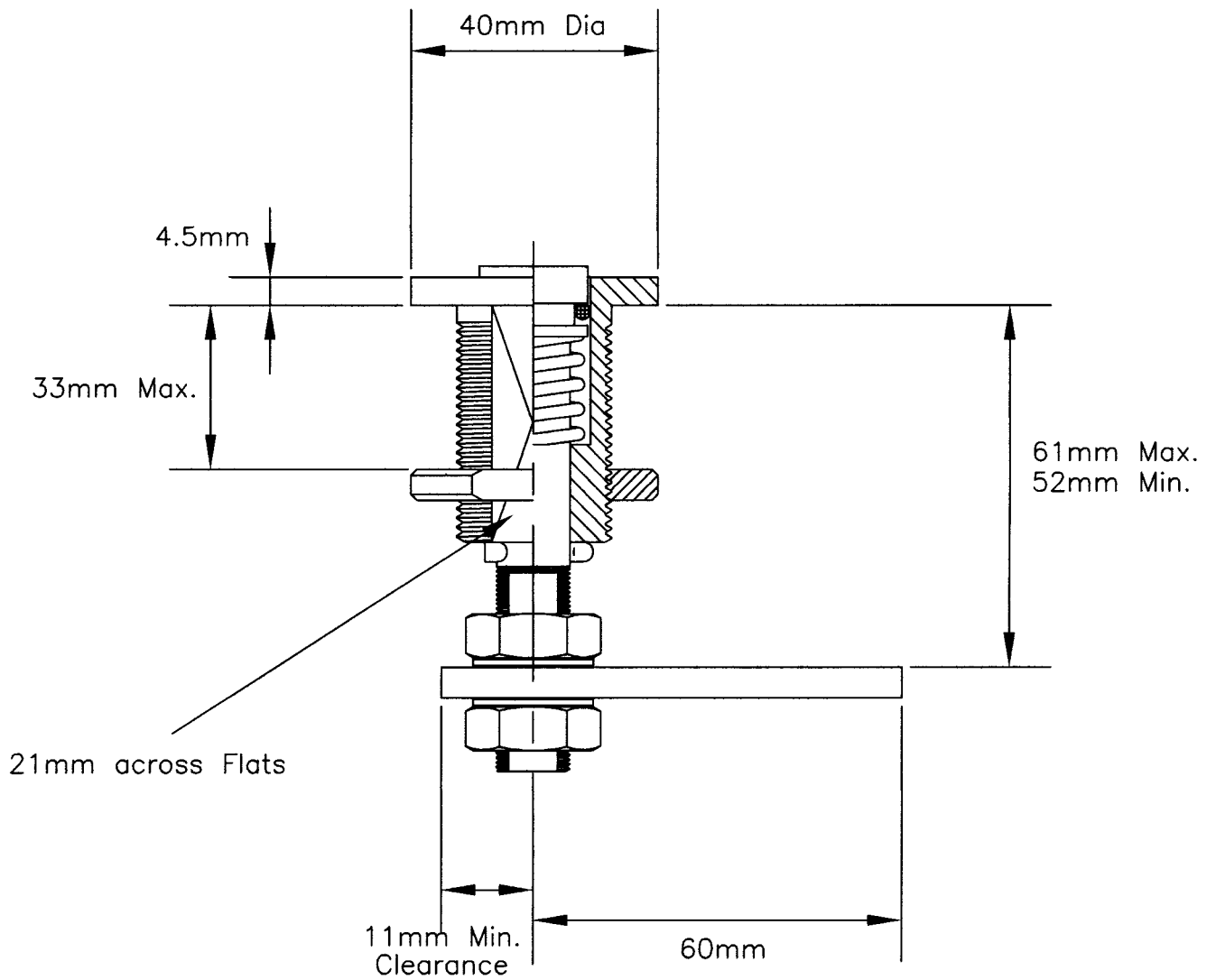

12Kg Holding Force

